



McIntosh Laboratory, Inc. 2 Chambers Street Binghamton, New York 13903-2699 Phone: 607-723-3512 www.mcintoshlabs.com

MC75 *60th Anniversary*
Tube Power Amplifier
Owner's Manual



The lightning flash with arrowhead, within an equilateral triangle, is intended to alert the user to the presence of uninsulated “dangerous voltage” within the product’s enclosure that may be of sufficient magnitude to constitute a risk of electric shock to persons.

WARNING - TO REDUCE RISK OF FIRE OR ELECTRICAL SHOCK, DO NOT EXPOSE THIS EQUIPMENT TO RAIN OR MOISTURE.

IMPORTANT SAFETY INSTRUCTIONS!

PLEASE READ THEM BEFORE OPERATING THIS EQUIPMENT.

1. Read these instructions.
2. Keep these instructions.
3. Heed all warnings.
4. Follow all instructions.
5. Do not use this apparatus near water.
6. Clean only with a dry cloth.
7. Do not block any ventilation openings. Install in accordance with the manufacturer’s instructions.
8. Do not install near any heat sources such as radiators, heat registers, stoves, or other apparatus (including amplifiers) that produce heat.
9. Do not defeat the safety purpose of the polarized or grounding-type plug. A polarized plug has two blades with one wider than the other. A grounding type plug has two blades and a



AVIS RISQUE DE CHOC ELECTRIQUE - NE PAS OUVRIR.

NO USER-SERVICEABLE PARTS INSIDE. REFER SERVICING TO QUALIFIED PERSONNEL.

third grounding prong. The wide blade or the third prong are provided for your safety. If the provided plug does not fit into your outlet, consult an electrician for replacement of the obsolete outlet.

10. Protect the power cord from being walked on or pinched particularly at plugs, convenience receptacles, and the point where they exit from the apparatus.
11. Only use attachments/accessories specified by the manufacturer.
12. Use only with the cart, stand, tripod, bracket, or table specified by the manufacturer, or sold with the apparatus. When a cart is used, use caution when moving the cart/apparatus combination to avoid injury from tip-over.
13. Unplug this apparatus during lightning storms or when unused for long periods of time.
14. Refer all servicing to qualified service personnel. Servicing is required when the apparatus has been damaged in any way, such as power-



The exclamation point within an equilateral triangle is intended to alert the user to the presence of important operating and maintenance (servicing) instructions in the literature accompanying the appliance.

To prevent the risk of electric shock, do not remove cover or back. No user-serviceable parts inside.

supply cord or plug is damaged, liquid has been spilled or objects have fallen into the apparatus, the apparatus has been exposed to rain or moisture, does not operate normally, or has been dropped.

15. Do not expose this equipment to dripping or splashing and ensure that no objects filled with liquids, such as vases, are placed on the equipment.
16. To completely disconnect this equipment from the a.c. mains, disconnect the power supply cord plug from the a.c. receptacle.
17. The mains plug of the power supply cord shall remain readily operable.
18. Do not expose batteries to excessive heat such as sunshine, fire or the like.
19. Connect mains power supply cord only to a mains socket outlet with a protective earthing connection.

IMPORTANT!

**INSTRUCTIONS FOR REMOVAL
OF FOAM INSERT OVER THE
VACUUM TUBES PRIOR TO
CONNECTING THE A.C. POWER
SUPPLY CORD, START ON THE
NEXT PAGE.**





Unpacking the MC75

Caution: To prevent damage to the MC75 Tubes during shipping, there is a special foam insert surrounding the Tubes of the Power Amplifier.

The Foam Insert must be removed from the MC75 before connecting the AC Power Supply Cord to the power amplifier.

Failure to do so has the potential of a Fire Hazard, resulting in damage to the MC75 and the surrounding environment.

Follow these instructions for removal of the packing foam before connecting the AC Power Supply Cord to the MC75.

In order to remove the foam insert surrounding the tubes on the MC75, it is necessary to temporarily remove the Tube Cover. After the foam insert is removed, the Tube Cover is re-installed and should not be removed. The cover provides protection from the hazardous voltages inside the MC75. The MC75 has no

user serviceable parts, including the tubes. If repairs are needed they must be performed by an authorized McIntosh Service Agency.

1. Orient the MC75 so the Front is facing you and remove the Warning Sheet. Refer to figure 1.
2. Using a Philips Head #2 screw driver, remove the Tube Cover Screw securing the Tube Cover to the chassis on each side of the MC75. Refer to figure 2. Carefully lift up and remove the Tube Cover from the MC75. Refer to figure 3.
3. Place the Tube Cover and the previously removed chassis screws in a safe location, as the Tube Cover will be reinstalled.

4. Carefully lift up and remove the Foam Insert from the MC75 exposing the Tubes. Refer to figures 4 and 5.

5. Carefully reinstall the previously removed Tube Cover using a Tube Cover Screw on each side of the MC75. Refer to figures 6, 7A, 7B and 8.

Note: Only use the chassis screws supplied with the MC75. If you can not find the chassis screws, contact the McIntosh Parts Department for replacements.

6. Save the Foam Insert and Warning Sheet with the MC75 Shipping Carton for possible future use.

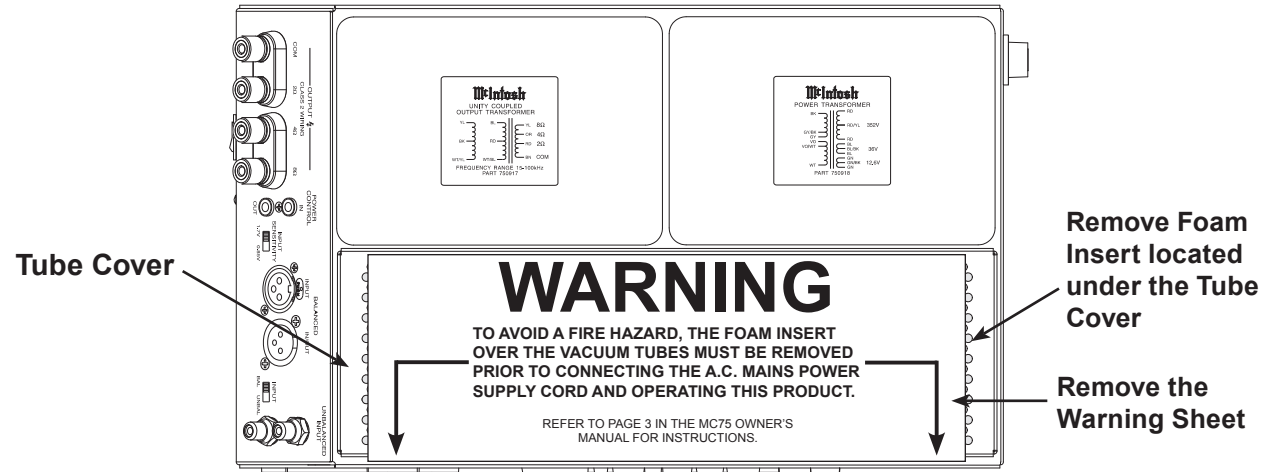

Figure 1

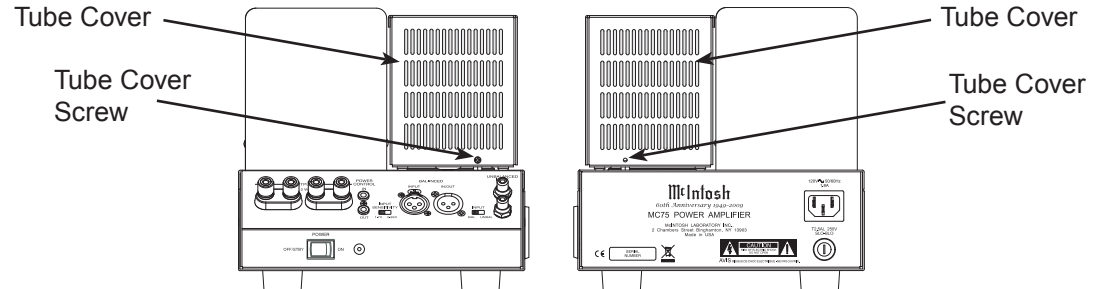

Figure 2

Figure 3

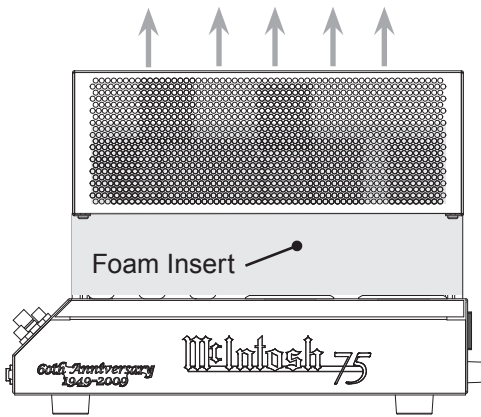

Figure 6

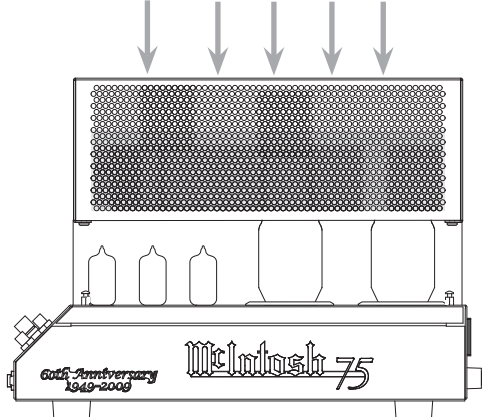

Figure 4

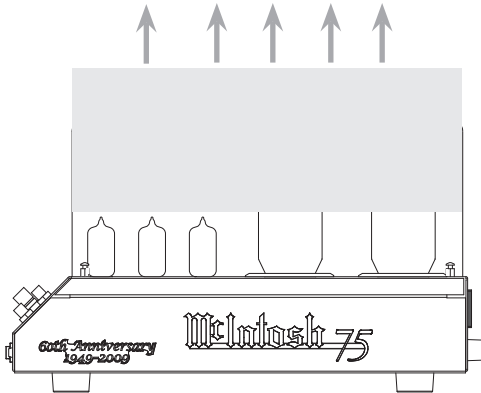

Figure 7A

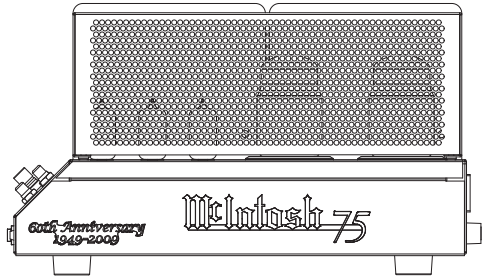

Figure 5

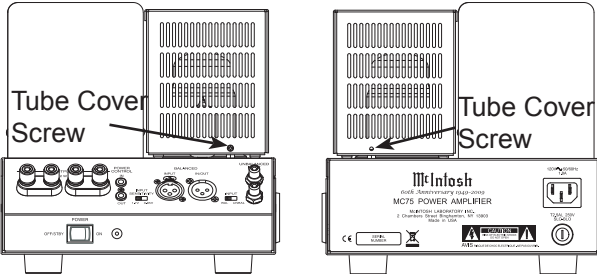
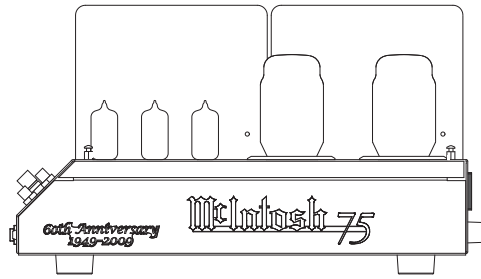

Figure 7B

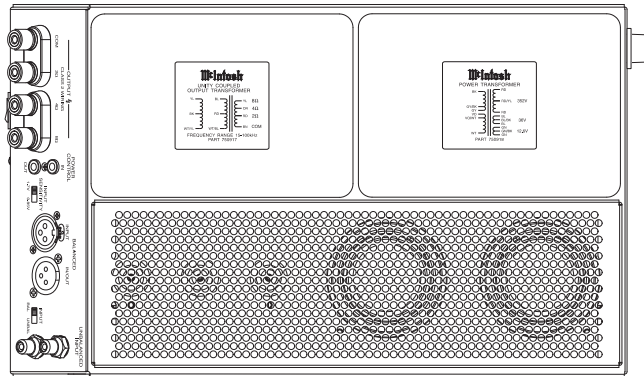

Figure 8

Ventilation

Adequate ventilation extends the trouble free life of the MC75. Always allow air to flow through the ventilation holes on the bottom of the amplifier and a means for the warm air to escape at the top. Refer to figure 9.

Allow at least 12 inches (30.48cm) above the top; 4 inches (10.16cm) for the Front, Rear and Sides; and 1/2 inches (1.27cm) below the Power Amplifier so the airflow is not obstructed.

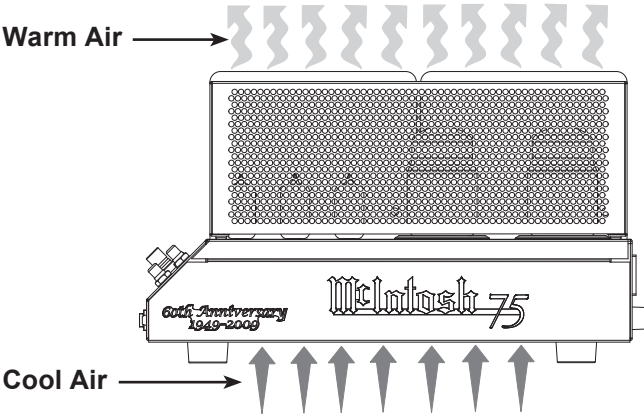

Figure 9



Thank You

Your decision to own this McIntosh MC75 Tube Power Amplifier ranks you at the very top among discriminating music listeners. You now have “The Best.” The McIntosh dedication to “Quality,” is assurance that you will receive many years of musical enjoyment from this unit.

Please take a short time to read the information in this manual. We want you to be as familiar as possible with all the features and functions of your new McIntosh.

Please Take A Moment

The serial number, purchase date and McIntosh Dealer name are important to you for possible insurance claim or future service. The spaces below have been provided for you to record that information:

Serial Number: _____

Purchase Date: _____

Dealer Name: _____

Technical Assistance

If at any time you have questions about your McIntosh product, contact your McIntosh Dealer who is familiar with your McIntosh equipment and any other brands that may be part of your system. If you or your Dealer wish additional help concerning a suspected problem, you can receive technical assistance for all McIntosh products at:

McIntosh Laboratory, Inc.
2 Chambers Street
Binghamton, New York 13903
Phone: 607-723-1545
Fax: 607-724-0549

Customer Service

If it is determined that your McIntosh product is in need of repair, you can return it to your Dealer. You can also return it to the McIntosh Laboratory Service Department. For assistance on factory repair return procedure, contact the McIntosh Service Department at:

McIntosh Laboratory, Inc.
2 Chambers Street
Binghamton, New York 13903
Phone: 607-723-3515
Fax: 607-723-1917

Table of Contents

Safety Instructions	2-3
Unpacking the MC75	4-5
Thank You and Please Take a Moment.....	6
Technical Assistance and Customer Service	6
Table of Contents	6
General Information	6
Connector Information	7
Introduction.....	7
Performance Features	7
Dimensions	8
Left Side Panel Connections, Right Side Panel Connections and Switch	9
How to Connect	10-11
Left Side Panel Display and Switches	12
How to Operate.....	13
Specifications.....	14
Packing Instruction.....	15

General Information

- The following Connecting Cable is available from the McIntosh Parts Department:
Power Control Cable Part No. 170-202
Six foot, 2 conductor shielded, with two 1/8 inch stereo mini phone plugs.
- For additional connection information, refer to the owner’s manual(s) for any component(s) connected to the MC75.
- The MC75 mutes the speaker output for approximately fifteen seconds when first turned on.
- For the best performance and safety it is important to always match the impedance of the loudspeaker to the Power Amplifier connections. Refer to step 5 on page 10.

Note: The impedance of a Loudspeaker actually varies as the Loudspeaker reproduces different frequencies. As a result, the nominal impedance rating of the Loudspeaker (usually measured at a midrange frequency) might not always agree with the impedance of the Loudspeaker at low frequencies where the greatest amount of power is required. Contact the Loudspeaker Manufacturer for additional information about the actual impedance of the Loudspeaker before connecting it to the McIntosh MC75.

- When discarding the unit, comply with local rules or regulations. Batteries should never be thrown away or incinerated but disposed of in accordance with the local regulations concerning battery disposal.
- For additional information on the MC75 and other McIntosh Products please visit the McIntosh Web Site at www.mcintosh-labs.com.



Connector and Cable Information

XLR Connectors

Below is the Pin configuration for the XLR Balanced Input, Input/Output Connectors on the MC75. Refer to the diagram for connection:

- PIN 1: Shield/Ground
- PIN 2: + Output
- PIN 3: - Output

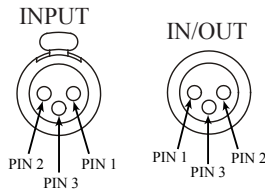

Power Control Connector

The MC75 Power Control Input receives an On/Off signal from +5 to +12 volts.

The Power Control Output will in turn provide a +12 volt Output Signal with a current up to 20mA. The 1/8 inch stereo mini phone plug connects to a McIntosh Preamplifier or A/V Control Center Power Control Output.

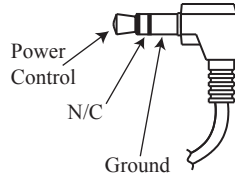

Note: The Power Control Connecting Cable is available from the McIntosh Parts Department:

Data and Power Control Cable Part No. 170-202

Six foot, shielded 2 conductor, with 1/8 inch stereo mini phone plugs on each end.

Introduction

Now you can take advantage of traditional McIntosh standards of excellence in the MC75 Tube Power Amplifier. The 75 watt power output will drive any high quality Loudspeaker System. The MC75 reproduction is sonically transparent and absolutely accurate. The McIntosh Sound is "The Sound of the Music Itself."

Performance Features

• Power Output

The MC75 is a Tube Power Amplifier with a capability of 75 watts into 2, 4 or 8 ohm speakers with less than 0.5% distortion.

• Unity Coupled Circuitry

The MC75 Power Amplifier uses the famous McIntosh Patented Unity Coupled Circuit which provides low distortion, extended frequency response and cool operating output tubes.

• Multifilar Wound Output Transformer

The MC75 Output Transformer Windings are part of the Unity Coupled Circuitry. There are two bifilar wound primaries, one for the cathodes and one for the plates. The secondary winding is wound together with the primary windings. This provides very close primary to secondary coupling. The result is flat frequency response and wide power bandwidth.

• Balanced and Unbalanced Input

Balanced connections guard against induced noise and allow long cable runs without compromising sound quality.

• Sentry Monitor Tube Protection

McIntosh Sentry Monitor Tube Protection Circuits ensure the MC75 will have a long and trouble free operating life.

• Gold Plated Connectors and Tube Socket Contacts

Gold Plated Input Jacks and Output Binding Posts provide trouble free connections. Ceramic tube sockets with gold plated contacts provide protection from atmospheric contamination. Output Tube Sockets include Air-Pipe cooling at their bases.

• Special Power Supply

A regulated Power Supply, a very large core Power Transformer and large capacitors ensure stable noise free operation even though the power line varies.

• Titanium Chassis with Super Mirror Finish

The famous McIntosh Stainless Steel Chassis with Super Mirror Gold Finish ensure the pristine beauty of the MC75 will be retained for many years.



Dimensions

The following dimensions can assist in determining the best location for your MC75.

Front View of the MC75

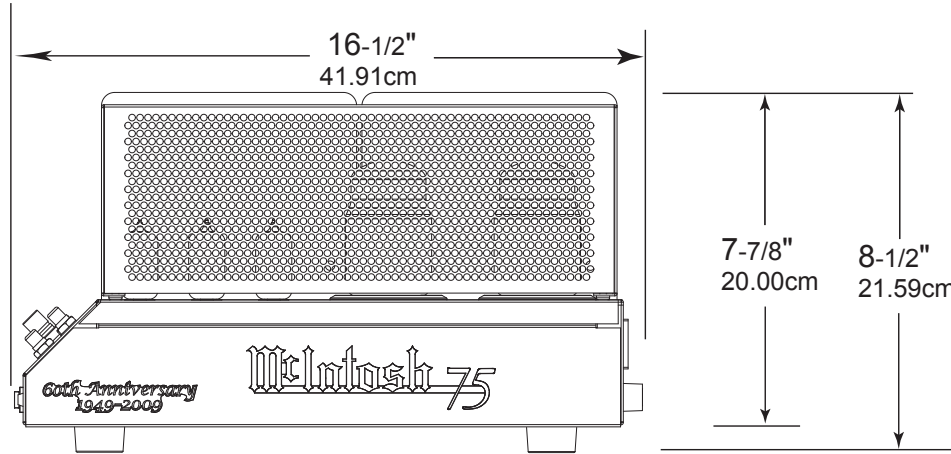

Left Side View of the MC75

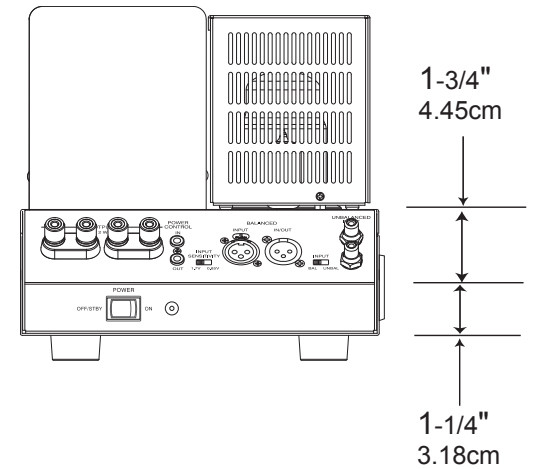

Top View of the MC75

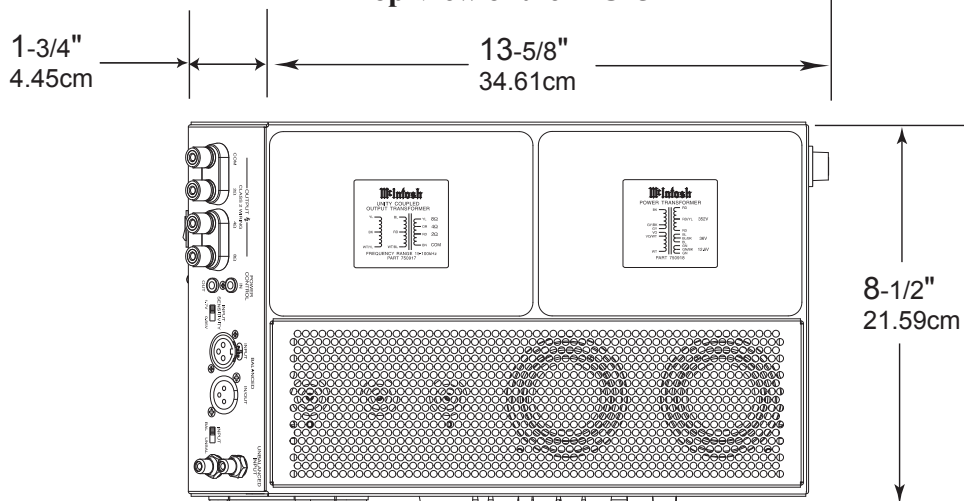

Right Side View of the MC75

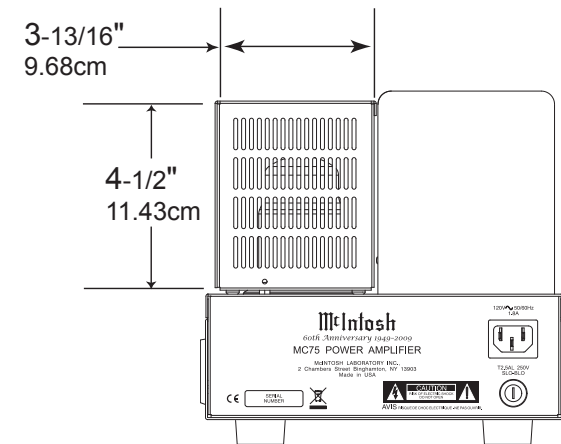

Left Side Connections, Right Side Connections and Fuse Holder

OUTPUT Connections for a 2, 4 or 8 ohm Loudspeaker

POWER CONTROL IN receives a turn On/Off signal from a McIntosh component
POWER CONTROL OUT sends a turn On/Off signal to the next McIntosh Component

UNBALANCED INPUT for an audio cable from a Preamplifier or A/V Control Center audio output

UNBALANCED INPut² / OUTput for an audio cable from a Preamplifier output or to connect an audio cable on to the next Power Amplifier input

Connect the MC75 power cord to a live AC outlet. Refer to the rear panel to determine the correct voltage

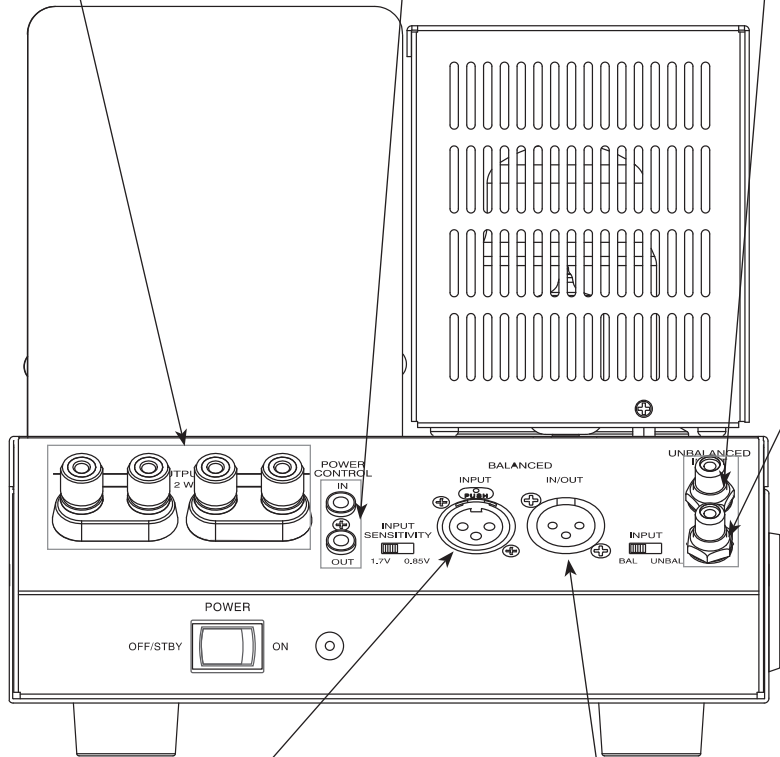

BALANCED INPUT for an audio cable from a Preamplifier or A/V Control Center audio output

BALANCED INPut¹ / OUTPut for an audio cable from a Preamplifier output or to connect an audio cable on to the next Power Amplifier input

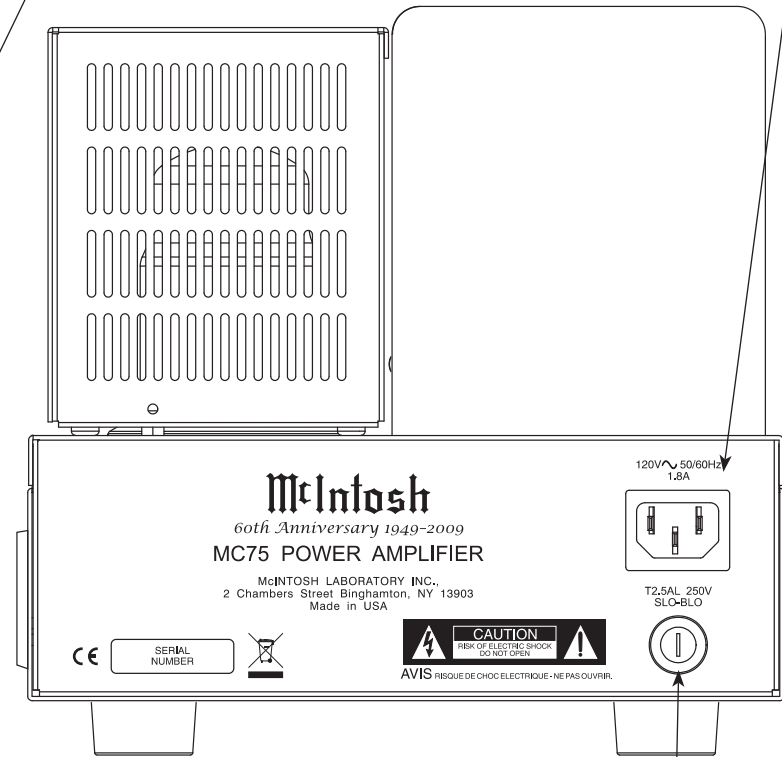

Fuse holder, refer to information on the side panel of your MC75 to determine the correct fuse size and rating

¹ This Balanced connector may be used as an Input ONLY when connected to a McIntosh C1000 Preamplifier. For all other connections use only as an Output.

² This Unbalanced connector may be used as an Input ONLY when connected to a McIntosh C1000 Preamplifier. For all other connections use only as an Output.

How to Connect

Caution: The supplied AC Power Cord should not be connected to the Rear Panel of the MC75 Tube Power Amplifier until after the Loudspeaker Connections have been made. Failure to observe this could result in Electric Shock. For additional instruction on making Loudspeaker Connections contact your McIntosh Dealer or McIntosh Technical Support.

1. For Remote Power Control, connect a power control cable from the Control Center or Preamplifier Power Control Out to the MC75 POWER CONTROL IN.
2. Connect a cable from the Balanced Output of a McIntosh Preamplifier or Control Center to the MC75 BALANCED INPUT. Place the INPUT MODE Switch in the BALANCED Position.

Note: An optional hookup is to use an unbalanced cable and place the INPUT MODE Switch in the UNBALANCED Position.

When connecting Loudspeakers to the MC75 it is very important to use cables of adequate size, so there is little to no power loss in the cables. The size is specified in Gauge Numbers or AWG (American Wire Gauge). The smaller the Gauge number, the larger the wire size:

Loudspeaker Cable Distance vs Wire Gauge Guide			
Loudspeaker Impedance	25 feet (7.62 meters) or less	50 feet (15.24 meters) or less	100 feet (30.48 meters) or less
2 Ohms	12AWG	10AWG	8AWG
4 Ohms	14AWG	12AWG	10AWG
8 Ohms	16AWG	14AWG	12AWG

3. This McIntosh MC75 Tube Power Amplifier is designed for the connection of a single Loudspeaker with an impedance of 2 ohms, 4 ohms or 8 ohms.

Note: The remaining Loudspeaker Terminals on the

Amplifier should not be connected to another Loudspeaker.

4. Prepare the Loudspeaker Hookup Cables that attach to the Amplifier by choosing one of the methods below:

Bare wire cable ends:

Carefully remove sufficient insulation from the cable ends, refer to figures 1, 2 & 3. If the cable is stranded, carefully twist the strands together as tightly as possible.

Note: If desired, the twisted ends can be tinned with solder to keep the strands together, or attach spade lug and/or banana connector.

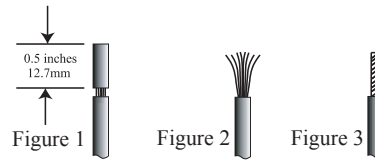

Spade lug or prepared wire connection:

Insert the spade lug connector or prepared section of the cable end into the terminal side access hole, and tighten the terminal cap until the cable is firmly clamped into the terminal so the wires cannot slip out. Refer to figures 4, 5 & 6.

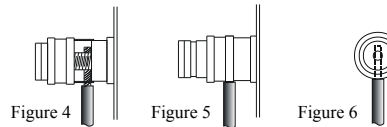

Banana plug connection:

Insert the banana plug into the hole at the top of the terminal. Refer to figures A and B.

Note: Banana Plugs are for use in the United States and Canada only.

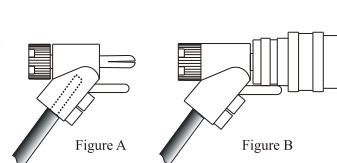

When making Loudspeaker Connections to the MC75

refer to the Connection Diagram on the next page. This is an example of a typical audio system, your system may vary from this, however the actual Loudspeaker would be connected in a similar manner.

5. Connect the Loudspeaker hookup cables from a single Loudspeaker to the MC75 Negative Output Terminal identified as COMMon and Positive Output Terminal identified as 2Ω (ohms), 4Ω (ohms) or 8Ω (ohms) connection that matches the impedance of the Loudspeaker, being careful to observe the correct polarities. If the Loudspeaker's impedance is in-between the available connections, use the nearest lower impedance connection. Refer to "General Information" Note 4 on page 6 for additional information.

WARNING: Loudspeaker terminals are hazardous live and present a risk of electric shock.

6. Connect the MC75 Power Cord to a live AC outlet.

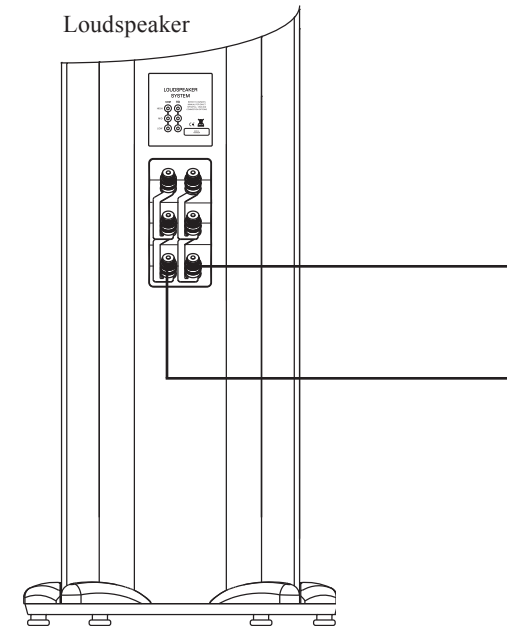

Preamplifier

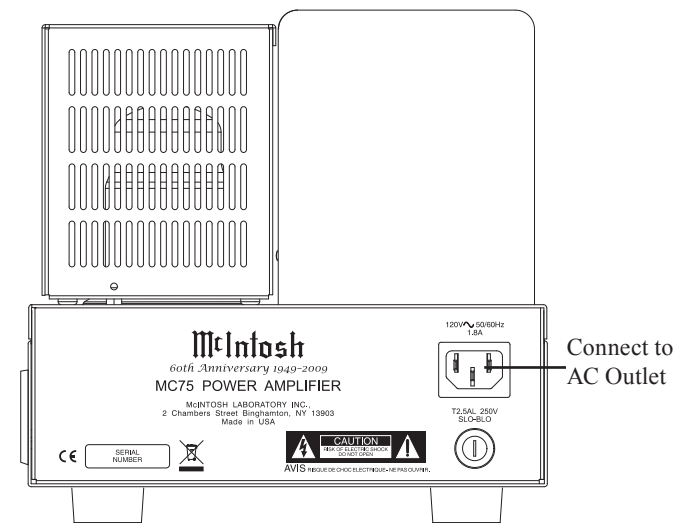
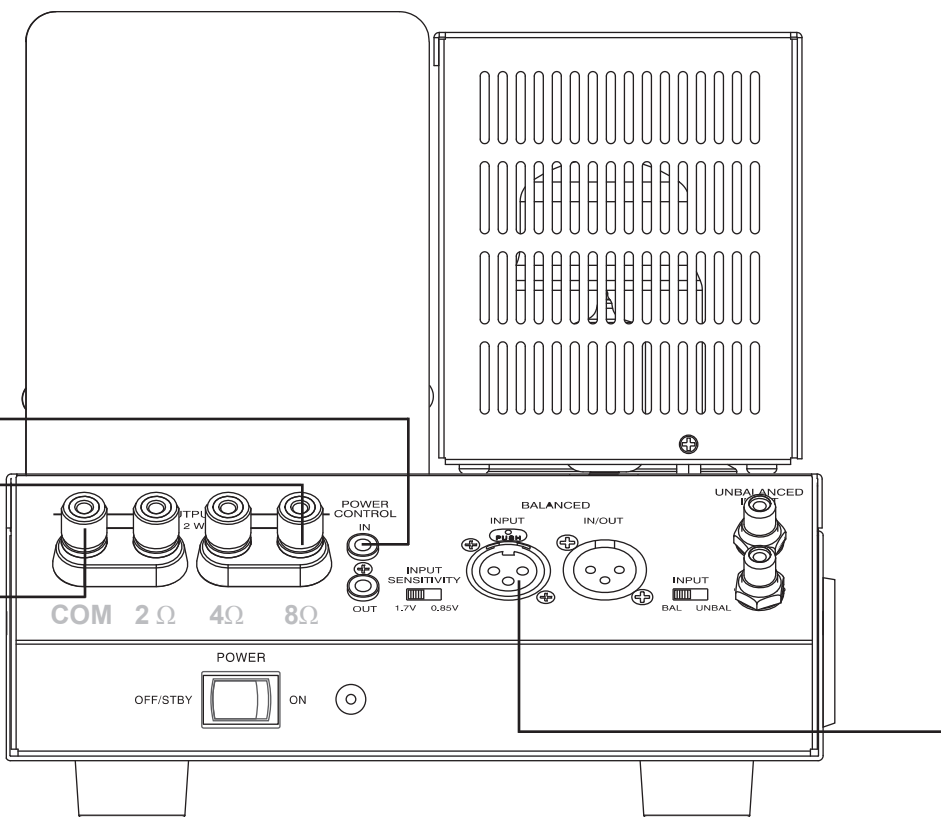
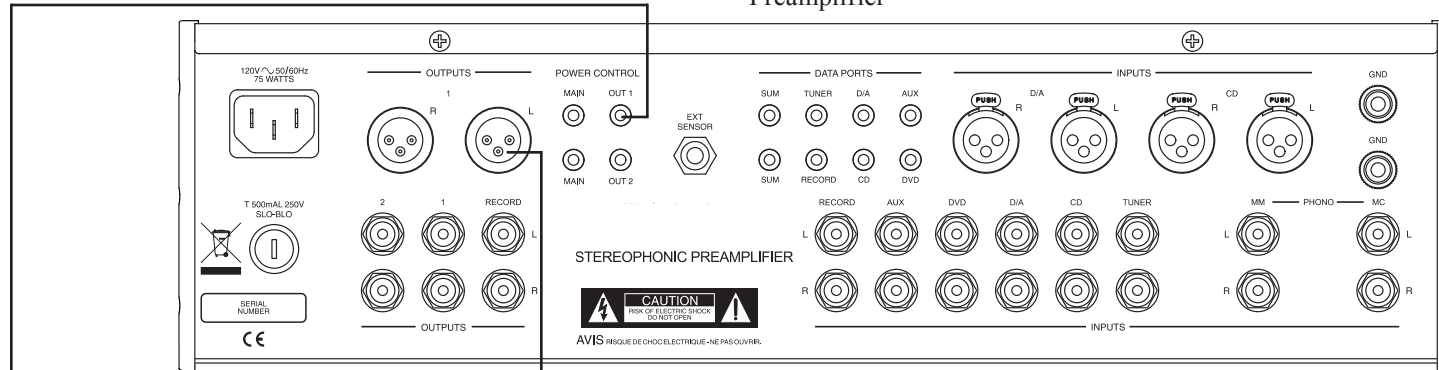

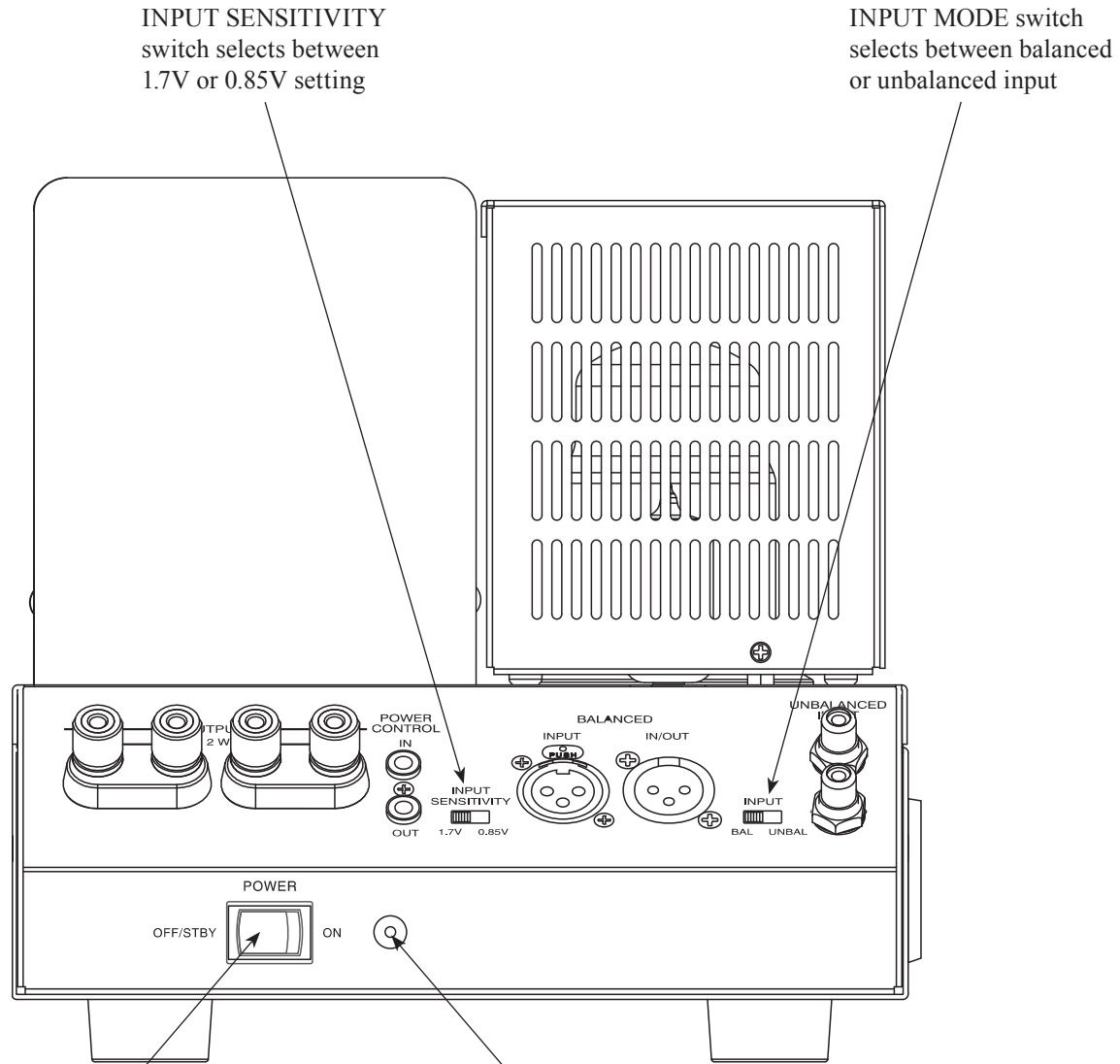

POWER Switch Turns AC Power ON, or OFF/STBY(Standby)

Standby Power On and Sentry Monitor Tube Protection Activation Indicator

How to Operate

Power On

To have the MC75 automatically turn On or Off when a Preamplifier or A/V Control Center turns on or off, place the Power Switch to OFF/STBY(Standby) position. For manual operation, place the Power Switch to the ON position as desired. Refer to figure 7.



Figure 7

Note: There must be a power control connection between the MC75 and the Preamplifier/A/V Control Center, in order for the remote power turn-on to function.

Input Mode Switch

The Input Mode Switch, which is located on the Left Side Panel of the MC75, allows you to select either the BAL (Balanced) or UNBAL (Unbalanced) Input. Refer to figure 8.

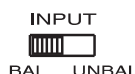

Figure 8

Input Sensitivity Switch

The Input Sensitivity Switch, which is located on the Left Side Panel of the MC75, allows matching the Preamplifier or A/V Control Center output voltage capability so the MC75 Power Amplifier can be driven to full power output. Refer to figure 9.

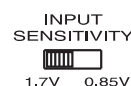

Figure 9

With the MC75 is connected to most McIntosh Preamplifiers or A/V Control Centers the correct setting of the Input Sensitivity Switch would be the 1.7V position.

While listening to a recording with a wide dynamic range, adjust the volume control on the Preamplifier or A/V Control Center so during the loud passages of the recording of the approximate rotational position of the Preamplifier or A/V Control Center Volume Control

is at the 2 O'Clock setting. If the Preamplifier or A/V Control Center has an Electronic Volume Display, adjust the Volume Display for an indication of 70% or 0dB.

This will help to assure the widest useful range of volume control settings especially when listening to music at lower levels. Refer to figure 9.

Standby/Protection Indicator

The MC75 Sentry Monitor Tube Protection Circuitry provides protection to the Power Amplifier in the event of an impedance mismatch¹ between the MC75 and the Loudspeaker. It will also activate if there is a short circuit at the MC75 Output Terminals (or the Loudspeaker Terminals) or if a MC75 Power Output Tube should fail. During normal operation the Sentry Monitor Tube Protection Circuitry has no effect on the performance of the Power Amplifier.

In the event a problem occurs, the MC75 Sentry Monitor Tube Protection Circuitry will activate to prevent potentially destructive high levels of current from flowing in the amplifier. The Front Panel Standby LED will start flashing indicating the Protection Circuitry has activated and the AC Power to the MC75 is halted. Refer to figure 10.



Figure 10

To reset the Sentry Monitor Tube Protection Circuitry first note the position of the POWER Switch. If the POWER Switch is set to the OFF/STBY position, switch Off the Preamplifier or A/V Control Center for approximately one minute and then switch the Preamplifier or A/V Control Center On. When the POWER Switch set to the ON position, place the POWER Switch to the OFF/STBY for approximately one minute, then place the POWER Switch to the ON position.

¹ The impedance of a Loudspeaker actually varies as the Loudspeaker reproduces different frequencies. As a result, the nominal impedance rating of the Loudspeaker (usually measured at a midrange frequency) might not always agree with the impedance of the Loudspeaker at low frequencies where the greatest amount of power is required. Contact the Loudspeaker Manufacturer for additional information about the actual impedance of the Loudspeaker before connecting it to the McIntosh MC75.



Specifications

Power Output

Minimum sine wave continuous average power output is:

- 75 watts into 2 ohm load
- 75 watts into 4 ohm load
- 75 watts into 8 ohm load

Output Load Impedance

2, 4 or 8 ohms

Rated Power Band

20Hz to 20,000Hz

Total Harmonic Distortion

0.5% maximum harmonic distortion at any power level from 250 milliwatts to rated power, 20Hz to 20,000Hz

Frequency Response

- +0, -0.5dB from 20Hz to 20,000Hz
- +0, -3.0dB from 10Hz to 100,000Hz

Input Sensitivity (for rated output)

- 1.7 Volt or 0.85 Volt Unbalanced
- 3.4 Volt or 1.7 Volt Balanced

Signal To Noise Ratio (A-Weighted)

110dB below rated output

Intermodulation Distortion

0.5% maximum, if the instantaneous peak power output does not exceed twice the rated power output for any combination of frequencies from 20Hz to 20,000Hz.

Wide Band Damping Factor

Greater than 18

Input Impedance

- 20,000 ohms Unbalanced
- 15,000 ohms Balanced

Tube Compliment

- 1 - 12AX7A Input and Phase Inverter
- 2 - 12AT7 Voltage Amplifier and Driver
- 2 - KT88 Power Output

Power Requirements

- 100V ~ 50/60Hz at 2.2 Amps
- 110V ~ 50/60Hz at 1.8 Amps
- 120V ~ 50/60Hz at 1.8 Amps
- 220V ~ 50/60Hz at 1.0 Amps
- 230V ~ 50/60Hz at 0.9 Amps
- 240V ~ 50/60Hz at 0.9 Amps
- Standby: 0.5 watt

Note: Refer to the right side panel of the MC75 for the correct voltage.

Overall Dimensions

- Width is 17-3/4 inches (45.09cm) including Cables
- Height is 8-1/2 inches (21.59cm) including feet
- Depth is 8-1/2 inches (21.59cm)

Weight

38 pounds (17.24 kg) net, 43.5 pounds (19.73 kg) in shipping carton

Shipping Carton Dimensions

- Width is 21 inches (53.34cm)
- Depth is 13-1/2 inches (34.29cm)
- Height is 15-1/8 inches (38.42 cm)

Packing Instructions

In the event it is necessary to repack the equipment for shipment, the equipment must be packed exactly as shown below. It is very important that the four feet are attached to the bottom of the equipment. This will ensure the proper equipment location on the bottom foam pad. Failure to do this will result in shipping damage.

To protect the tubes during shipment, the Foam Insert removed from the MC75 needs to be re-inserted. Follow the unpacking instructions on pages 4-5 in the reverse order.

Use the original shipping carton and interior parts only if they are all in good serviceable condition. If a shipping carton or any of the interior part(s) are needed, please call or write Customer Service Department of McIntosh Laboratory, refer to page 3. Please see the Part List for the correct part numbers.

Quantity	Part Number	Description
1	034469	Shipping carton
1	034468	Foam Pad Top
2	034474	Foam Pad Bottom
1	034471	Foam Insert (for protecting the Tubes during shipping)
1	041122	Warning Sheet
4	400131	10-32 x 1/2 inch screw
4	163073	Feet

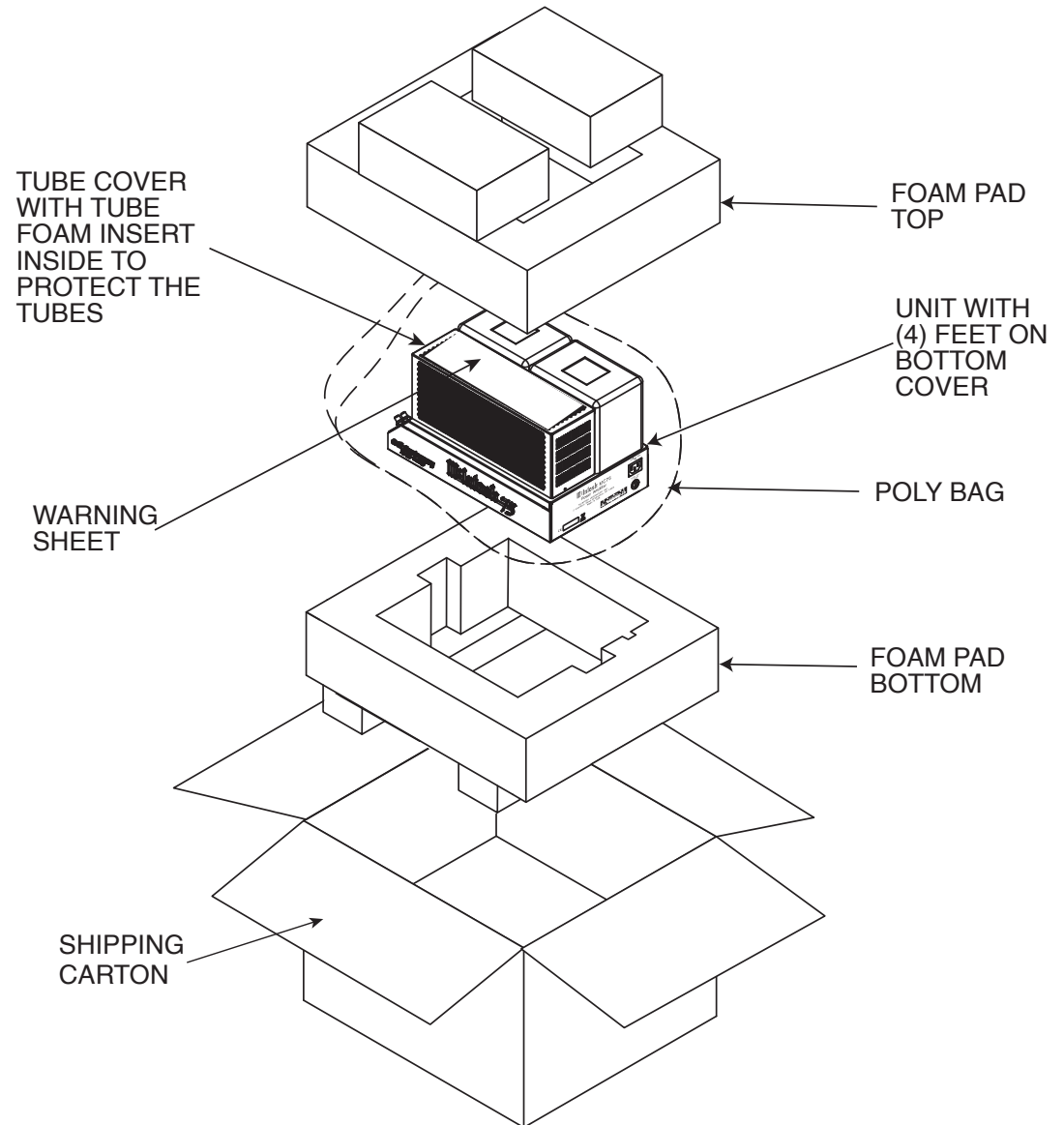



McIntosh Laboratory, Inc.
2 Chambers Street
Binghamton, NY 13903
www.mcintoshlabs.com

The continuous improvement of its products is the policy of McIntosh Laboratory Incorporated who reserve the right to improve design without notice.
Printed in the U.S.A.